

FURUNO

NETWORK MULTI-BEAM SONAR

Model **DFF-3D**

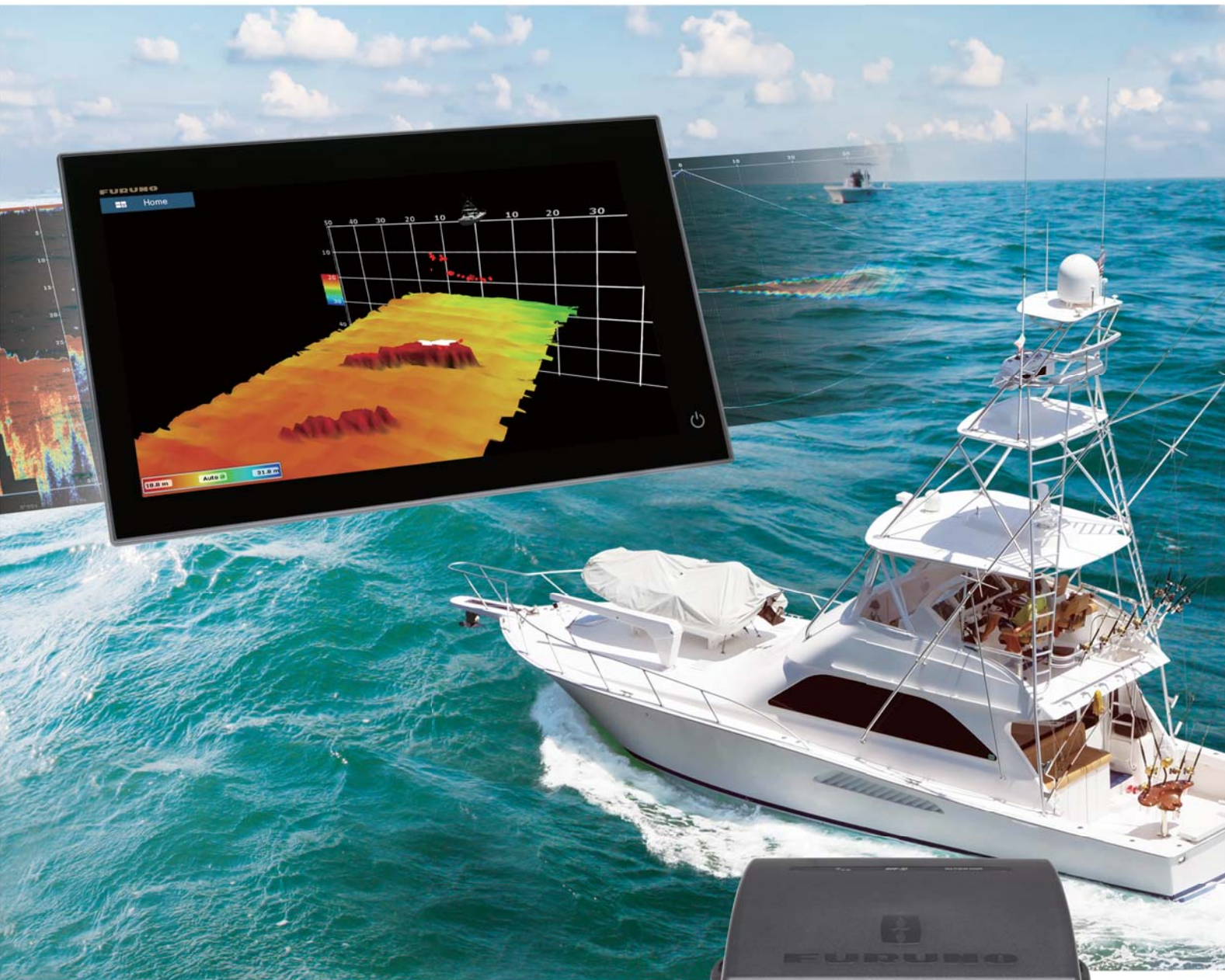

wassp
MULTIBEAM
SEE IT ALL

www.furuno.com

Revolutionary 3D multi-beam sonar utilizing FURUNO's Display deep and wide water columns and seabeds in astonishing high definition detail in real time.



Visibly see the landscape and fish schools at great depths in amazing detail

Turn your NavNet TZtouch or TZtouch2 MFD into a multi-beam sonar that can see 120-degrees port to starboard, allowing you to see the depth and direction fish schools are moving, while displaying the seabed condition in real time.

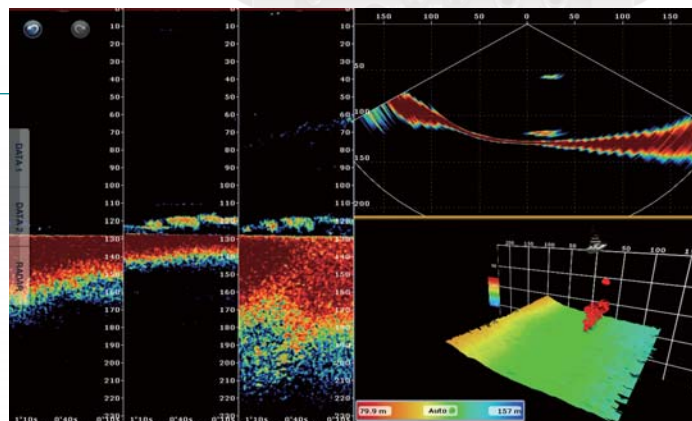

Depth: 130 m

- ▶ Sidebar detection range is up to 200 m (over 650 ft)* in a 120-degree swath port and starboard direction.

* Depending on bottom, water and installation conditions.

- ▶ Deep water, main beam penetration directly under the boat is approx. 300 m (over 980 ft)*.

* Depending on bottom, water and installation conditions.

- ▶ Customize the display according to your needs.

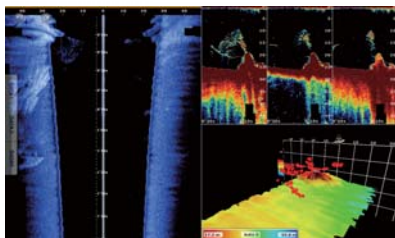

Depending on the situation and preference, a combination of screen modes can be displayed.

- ▶ The compact transducer allows easy installation.

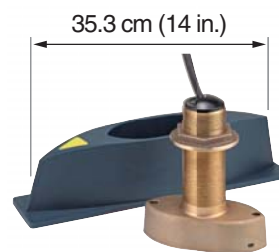

Compact transducer with fairing block

- ▶ The built-in motion sensor (standard supply) stabilizes the display to give clear and stable images even under rough sea conditions.

advanced multi-beam technology.



What is multi-beam sonar?

The DFF-3D is an innovative tool for efficient fish location and seabed profile surveying, utilizing new multi-beam technology. Highly detailed images are derived from the combination of an advanced signal processing system and an amazingly compact multi-beam transducer.

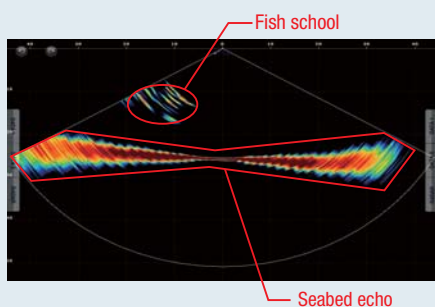

Cross Section

Cross section displays the real-time sea column echo in 120 degrees port and starboard. This mode aids in instantly understanding the distribution of bait fish and the water column condition.

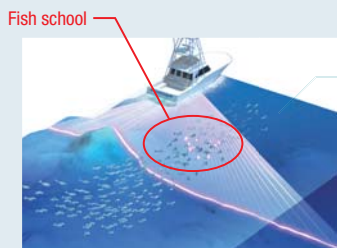
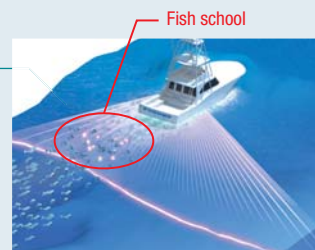

3D Sounder History

The 3D sounder history provides an intuitive and easy to understand 3D image of the seafloor, along with fish school icons. This mode is useful in a variety of situations, such as selecting a fishing hot spot and assessing the seabed condition.

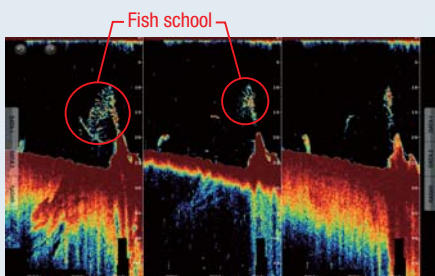
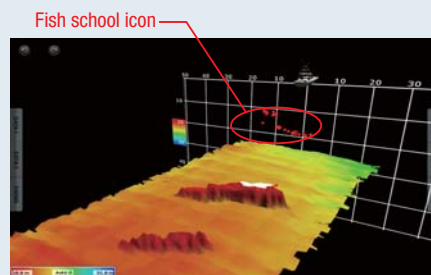

Triple/Single Beam Sounder

A single (directly under boat) or triple direction (middle, left and right) fish finder image are displayed simultaneously. The Triple beam display helps to understand the depth of fish targets and the seabed condition in each direction, as well as the direction the target fish are moving. Each beam angle and beam width are selectable.

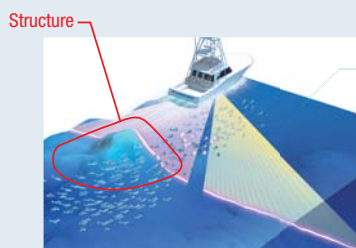
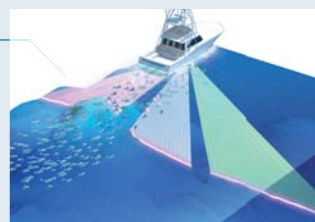

Side Scan

Side scan clearly displays the shape of structure as a high definition image in port and starboard direction. It is suitable for searching the seabed and understanding the sea floor structure.

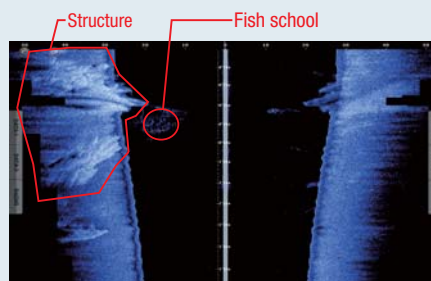

SPECIFICATIONS OF DFF-3D

GENERAL

TX Frequency	165 kHz
Output Power	800 W
Minimum Range	3 m
Basic Range	5-1200 m
Detection Range	200 m* (Side Beam Best Performance) 300 m* (Main Beam Directly Under Boat)
	*Depending on bottom, water and installation.

Beam Angle for Triple Beam Sounder Display Mode	20°-50° from right under Triple/Single Beam Sounder, Side Scan, Cross Section, 3D Sounder History
---	---

INTERFACE

LAN	1 port, Ethernet 10/100Base-TX
External KP	1 port (optional external KP kit required)

ENVIRONMENT

Temperature	-15°C to + 55°C
Relative humidity	93% or less at +40°C
Waterproofing	IP55

POWER SUPPLY

DFF-3D	12-24 VDC, 1.4-0.7 A
Rectifier (PR-62, option)	100/110/220/230 VAC, 1 phase, 50/60Hz

Equipment List

Standard

Multi-Beam Sonar	DFF-3D
Transducer	B-54
Spare Parts, Installation Materials	

Option

External KP Kit	
Cable Assembly (2 m/10 m)	
Rectifier	PR-62

INTERCONNECTION DIAGRAM

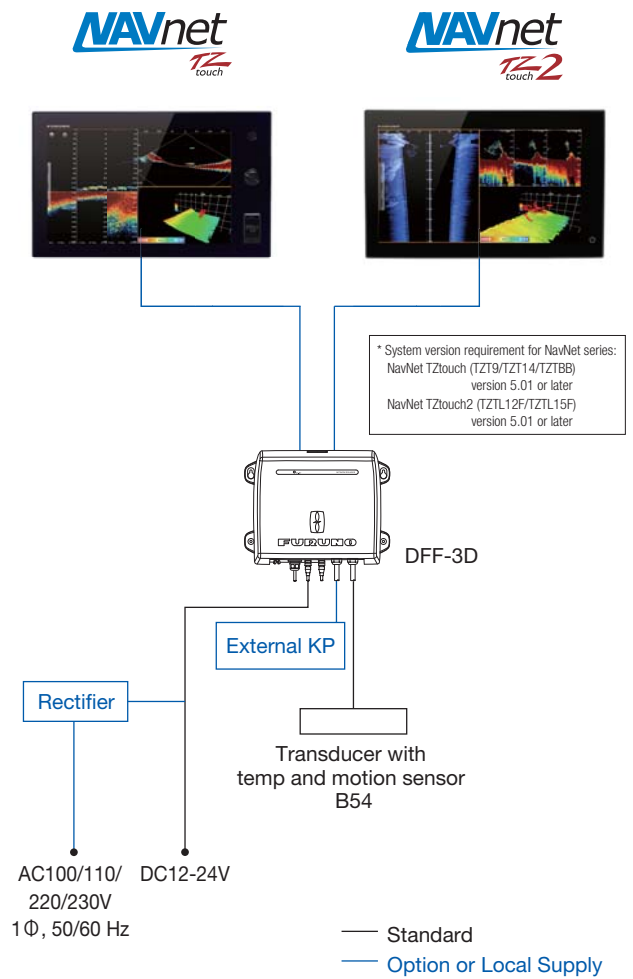

PROCESSOR UNIT

DFF-3D 3.0 kg 6.6 lb

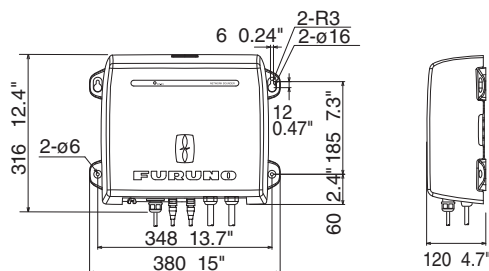

Transducer with Fairing Block

B-54 3.2 kg 7 lb

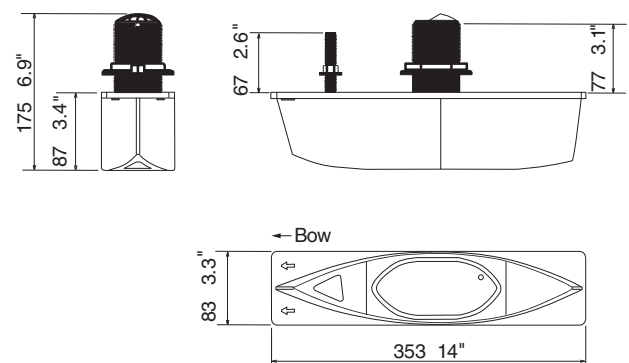

Beware of similar products

All brand and product names are registered trademarks, trademarks or service marks of their respective holders.

SPECIFICATIONS SUBJECT TO CHANGE WITHOUT NOTICE

FURUNO ELECTRIC CO., LTD.
Nishinomiya, Hyogo, Japan
www.furuno.com

FURUNO U.S.A., INC.
Camas, Washington, U.S.A.
www.furunousa.com

FURUNO (UK) LIMITED
Havant, Hampshire, U.K.
www.furuno.co.uk

FURUNO FRANCE S.A.S.
Bordeaux-Mérignac, France
www.furuno.fr

FURUNO ITALIA S.R.L.
Gatteo Mare, Italy
www.furuno.it

FURUNO ESPAÑA S.A.
Madrid, Spain
www.furuno.es

FURUNO DANMARK A/S
Hvidovre, Denmark
www.furuno.dk

FURUNO NORGE A/S
Ålesund, Norway
www.furuno.no

FURUNO SVERIGE AB
Västra Frölunda, Sweden
www.furuno.se

FURUNO FINLAND OY
Espoo, Finland
www.furuno.fi

FURUNO POLSKA Sp. Z o.o.
Gdynia, Poland
www.furuno.pl

FURUNO EURUS LLC
St. Petersburg, Russian Federation
www.furuno.ru

FURUNO SINGAPORE
Singapore
www.furuno.sg

FURUNO DEUTSCHLAND GmbH
Rellingen, Germany
www.furuno.de

FURUNO HELLAS S.A.
Piraeus, Greece
www.furuno.gr

FURUNO (CYPRUS) LTD
Limassol, Cyprus
www.furuno.com.cy

FURUNO CHINA CO., LTD.
Hong Kong
www.furuno.com/cn

FURUNO SHANGHAI CO., LTD.
Shanghai, China
www.furuno.com/cn

1-B-1701PDF
Catalogue No. CA00001071